

## Product Installation guide

**IP65**



-10 to 50°C

OPERATION TEMPERATURE



MAKE SURE THE Power IS OFF DURING INSTALLATION



220-240V~  
50/60 Hz

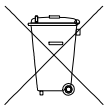

RISK OF FIRE AND ELECTRICAL SHOCK

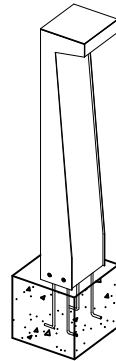
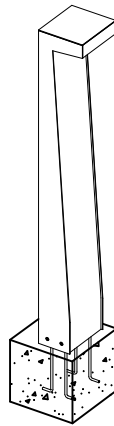

## INSTALLATION INSTRUCTIONS

## DISCLAIMER

Please read all instructions before beginning installation:

1. Turn off electrical Power before starting the installation of the light fixture.
2. The feeding voltage must not exceed the specified fixture voltage.
3. This product must be installed by an eligible electrician.
4. Make sure the luminaire is mounted to a secure structure. Mounting the fixture in inappropriate way could lead to serious injury.
5. This luminaire is class 1, it must be earthed in a reliable way.
6. Wear gloves and safety glasses at all times when removing the luminaire from carton, installing, servicing or performing maintenance
7. Do not install damaged product! This luminaire is properly packed to avoid being damaged during transit. Inspect to confirm before installation. Any damaged or broken part during or after assembly should be replaced.
8. Unauthorized repairs or modifications will void warranty.

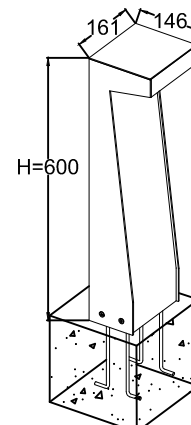
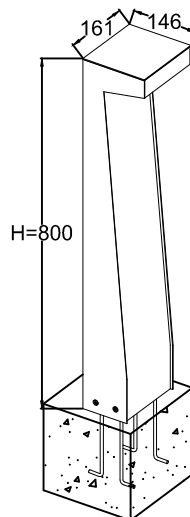
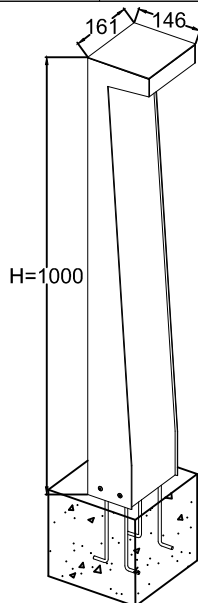

Dimensions in mm

## Product Installation guide

### 1. Prepare the ground and the cable with a proper drainage system

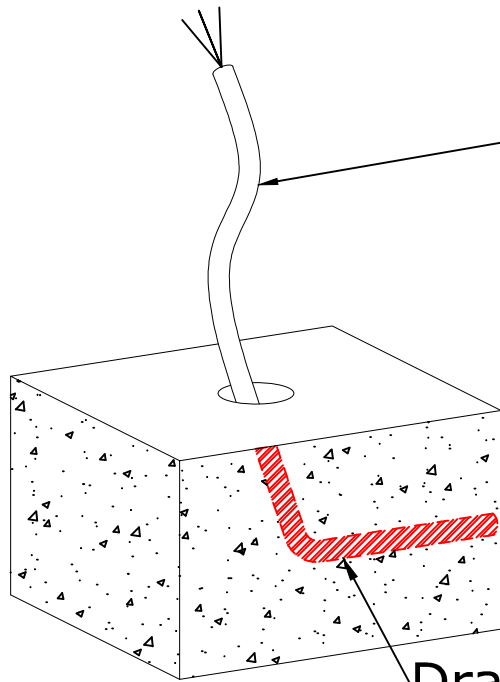

Type	Application	Cable	Note
Non Dimmable	Power	H07RN F 3G1.0 mm <sup>2</sup>	L/N/PE
DALI	Power & Control	H07RN F 5G1.0 mm <sup>2</sup>	L/N/PE/DA/DA
1-10V	Power	H07RN F 3G1.0 mm <sup>2</sup>	L/N/PE
	Control	H07RN F 2x1.0 mm <sup>2</sup>	DIM+ / DIM-

Drainage

### 2. Install the anchor base in the ground level

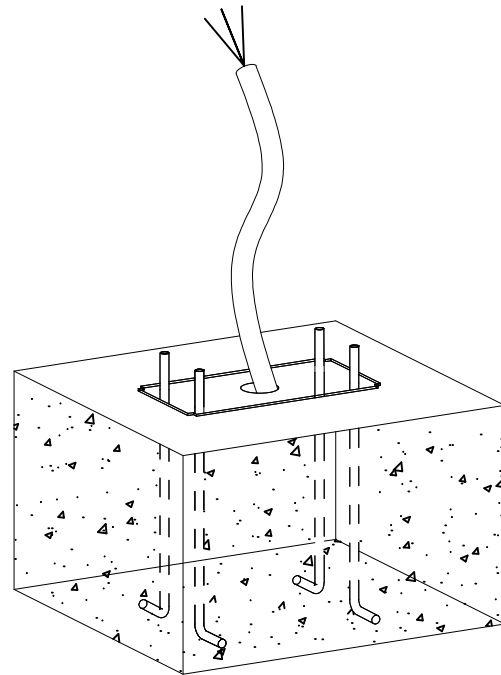
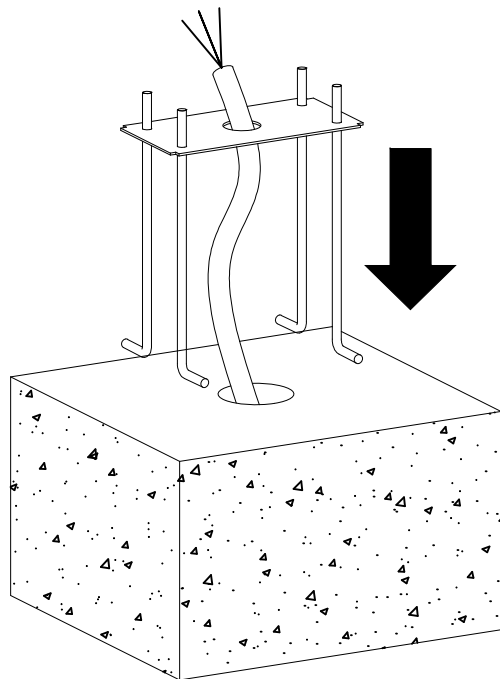

Make sure the cable pass through the hole base

## Product Installation guide

### 3. Slide the inner base into the anchor base

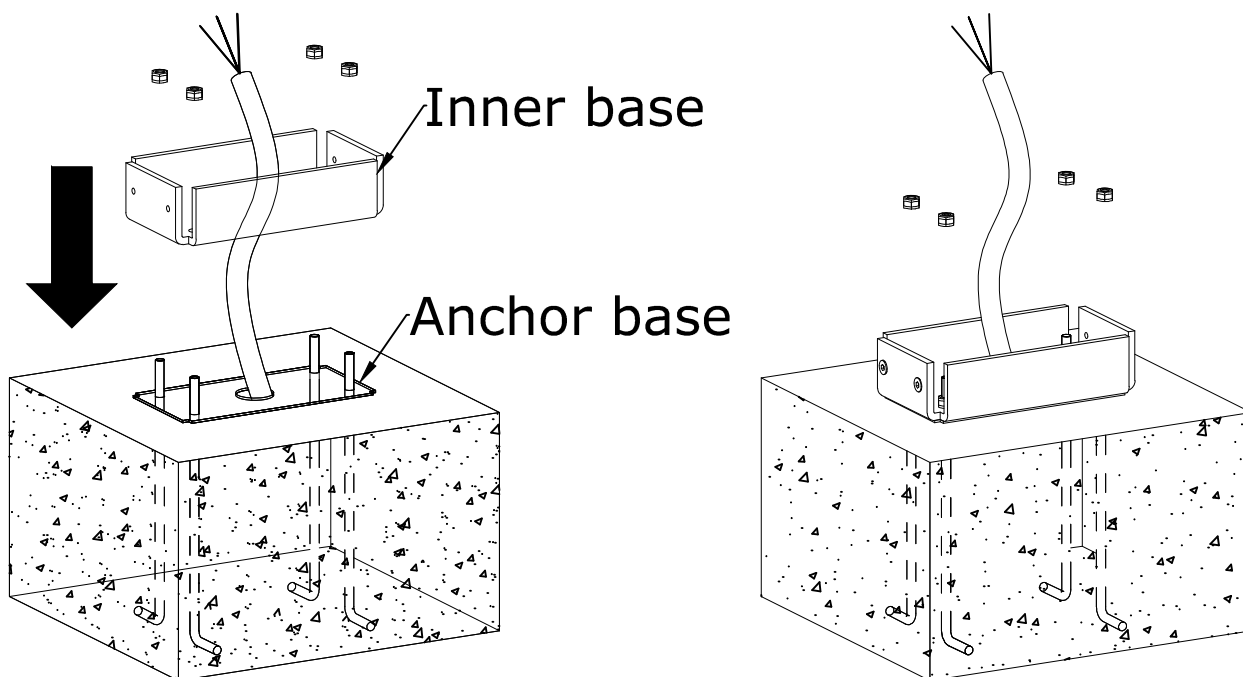

### 4. Tighten the nuts

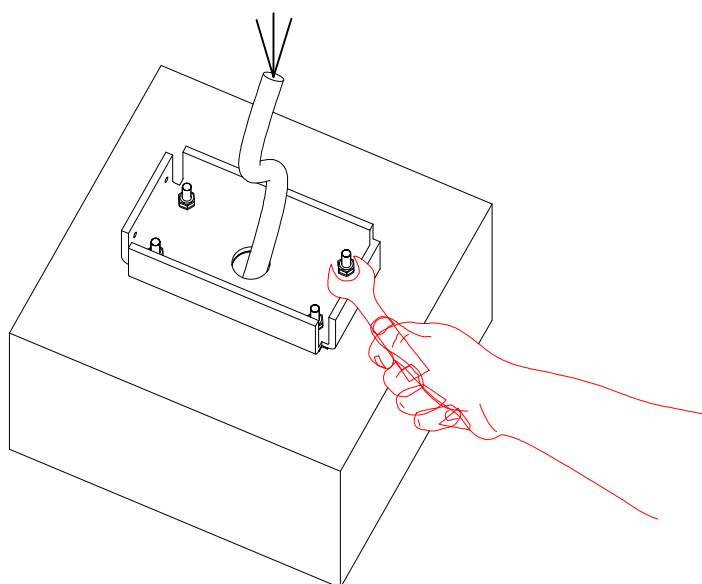

## Product Installation guide

### 5. Fix and screw in E-Walk fixture using M4 countersunk screw with the base bracket

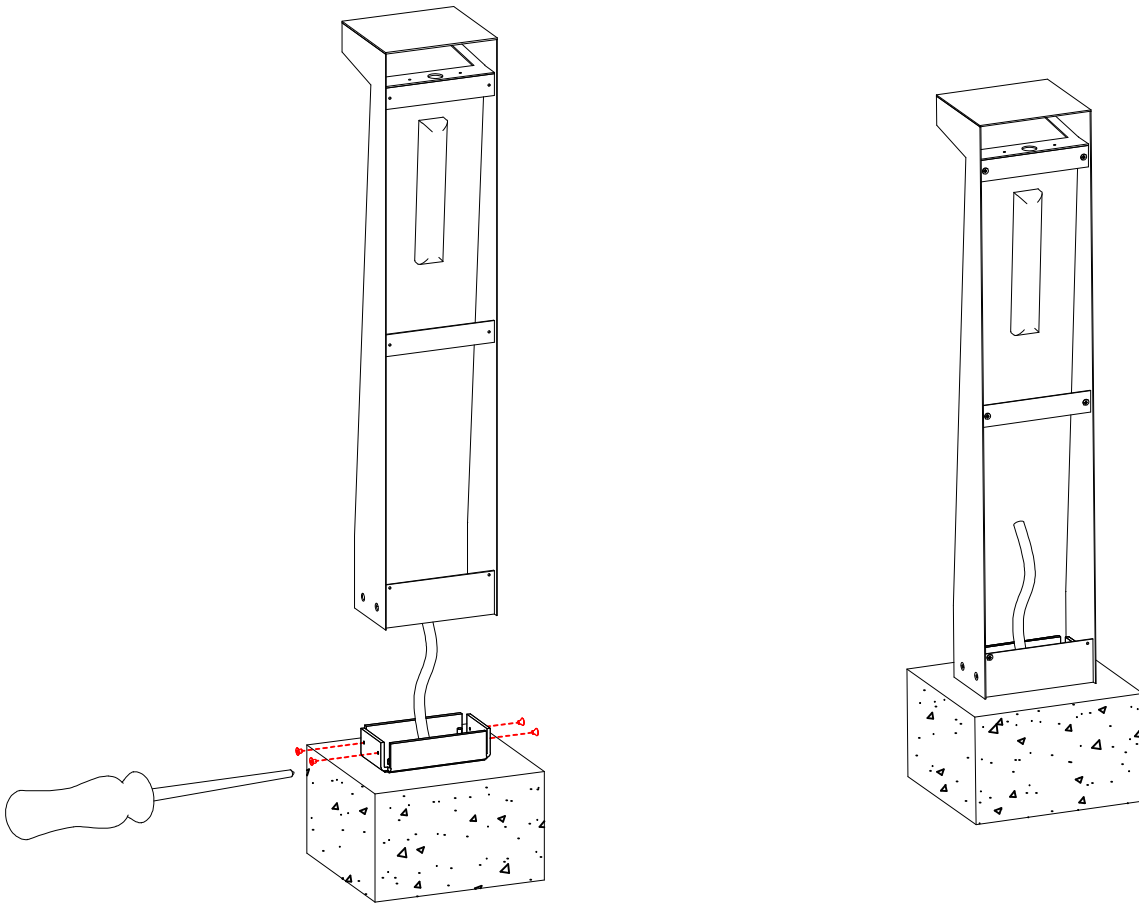

### 6. Connect Power line using waterproof connector

Non Dimmable

3Poles

	Brown	: Line
	Blue	: Neutral
	Green/Yellow	: Ground

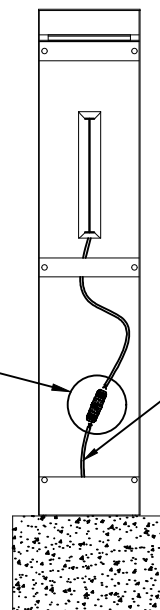

Use cable  
H07RN F 3G1.0 mm<sup>2</sup>

## Product Installation guide

### Dali Dimmable

5Poles



Brown	: Line
Blue	: Neutral
Green/Yellow	: Ground
Black	: DALI
Grey	: DALI

Use cable  
H07RN F 5G1.0 mm<sup>2</sup>

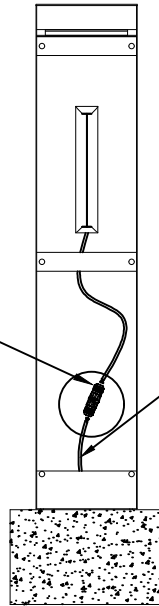

### 1-10V Dimmable

3Poles



Brown	: Line
Blue	: Neutral
Green/Yellow	: Ground

Use cable  
H07RN F 3G1.0 mm<sup>2</sup>

2Poles



Brown	: Dim+
Blue	: Dim-

Use cable  
H07RN F 2x1.0 mm<sup>2</sup>

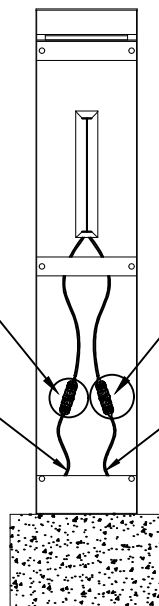

## Product Installation guide

### 7. Fix back cover using M4 countersunk screw

